



Tuff Rib and/or Diamond Rib (Wall Steel) Metal Installation Manual 36" Panels

NOTE: The details and written instructions described in this manual are suggested installation methods to ensure a quality application of our products and should be considered as a guideline only. Wise Line Metal Sales recognizes that installation techniques can vary based upon builder and geographical preferences, and that there are other acceptable ways to install our products.

(Roof Pitch)

To ensure the required water drainage of properly installed metal roofing panels a minimum pitch of 2/12 (2/12 means there is 2" of rise for every 12" running horizontally) is required. Metal roofing stitch screws and butyl tape must be applied to the laps to prevent the siphoning of water over the ribs on a low slope application. If the pitch is 4/12 or greater, stitch screws and butyl tape are not required and underlay is optional. A good underlayment needs to be installed prior to the panels on roof pitches less than 4/12.

(Ordering Roof Panels and Screws)

When a vented ridge system is being used panels should be 2" short of the ridge. Where transition/ pitch change flashing is required, panel lengths need to be adjusted to accommodate flashing. All sheeting lengths should be verified based on measurements prior to ordering. (See diagram on - Pg. 7) Metal panels should be installed with a #10 woodgrip screw with a neoprene washer (here after referred to as metal screws) in the flat of the metal of metal beside the major rib. (See page 4 for screw patterns.) Screws can also be screwed through the ribs.

(Ordering and Applying Trim)

The ridge cap is used at the peak of a roof where opposing roof slopes join. Other typical flashings include eave flashing which is at the bottom by the gutter, gable flashing, sidewall and endwall flashing (is used where your roof joins a wall on the side or end of your metal sheets), valleys and transitions. The roof slope should be mentioned when ordering ridge caps, endwalls and eave flashing when the slope is 5/12 or greater, all standard trims are designed for a 4/12 pitch. When ordering a transition, where a steeper slope meets a lesser slope, both slopes are required.

The use of gable drip edge trim protects the gable end and adds to the appearance of the structure. It is to be fastened approximately every 12" to the face of the building or fascia where applicable with metal screws. On a roofline where the edge of a panel ties into a wall, a sidewall or endwall flashing it is required to slip up under the wall cladding and over the roof sheeting. In both cases, butyl sealant tape or caulking are required to ensure a water-tight seal between the flashing and cladding. (See diagram on Pgs. 6)

At the Ridge, outside or vented closures should be installed between the Ridge Cap and the roof panel to prevent the penetration of driving rain or foreign debris. The Ridge is fastened with metal screws through the rib of the metal and can be stitched to the rib or fastened down into the strapping or solid substrate. Be sure to select the correct length to accommodate your preference of installation as both methods are acceptable



Tuff Rib and/or Diamond Rib (Wall Steel) Metal Installation Manual 36" Panels continued

(Roof Application)

If installing over existing shingles the roof should be strapped with minimum 1" x 4" strapping at 24" on centres

- Panel Installation should begin at the gable end of the roof opposite the prevailing rain bearing wind (this will help ensure that wind driven rain will not penetrate the lap).
- The minimum roof slope recommended is 4" in 12" of rise (4/12 pitch). You can apply metal roofing to as low a pitch between 2" in 12" of rise and less than 4" in 12" of rise. This is called a low slope application and requires extra steps (see above under roof pitch).
- On an end lap ensure the panel above overlaps the lower panel. Use 6" of overlap at the end laps. For low slope you should overlap by at least 9". Two rows of Butyl tape should be applied across the panels between the panels at end laps. It is also advisable to apply butyl tape where panels and trims meet. NOTE: Account for overlap when ordering steel.
- At the Gable ends extend the sheet 1" beyond the gable fascia (See dia. 3 pg 9) unless you are using a Gable starter Trim in which case the sheet should be flush (See dia. 4 pg 9). Other options are also available see dia 1-5 pg 9.
- An overhang of $\frac{3}{4}$ " to 1" at the eave is recommended. - Measure one panel width in from the gable end and run a chalk line from the eave to the ridge.
- For the remaining panels to line up square across the roof it is critically important this first panel is laid square to the eave and ridge.
- Closures should be used along the entire ridge.
- Screws should be placed every two feet down the length of the panel and on the left hand side of the major rib if you are working from right to left and on the right hand side if you are working left to right. Screws should be placed on both sides of the major rib along the eaves. At the ridge do not fasten until you are installing the ridge cap at which time you will drive your fastener through the ridge cap, closure and major ribs of the panel. (Refer to screw application diagram at Pg. 7)

(Siding Application)

The standard fastening and overlap patterns should be used when installing siding to ensure optimum performance. Hemmed corner flashings should be used for strong neat corners. Other flashings you will use when installing side panels are drip cap (over windows), "J" Trim (around windows and doors) and door jamb flashing. You should not run siding panels all the way to the ground and the bottom edge should be terminated on a base flashing (See Diagram of Base Trim dia 20 - Pg 11). When the wall consists of more than one panel in each vertical row use Gable divider then install top sheets (see dia 16 Pg 11). Siding panels installed horizontally should have butyl tape or caulking applied at the vertical laps. This will ensure weather-tite joints.



Tuff Rib and/or Diamond Rib (Wall Steel) Metal Installation Manual 36" Panels continued

(Trimming & Cutting Steel Panels)

For cutting panels the best device(s) are hand shears, nibblers or circular saw with a proper metal cutting blade (a cold cut metal cutting circular saw blade sold at Wise Line Tools). You have to be particularly careful when using nibblers or a circular saw as they both have a tendency to leave hot metal particles that can burn the paint surface or leave rust marks on panels and trims. Filings can also be left by the application of screws. All of which could impact the terms of the product warranty. Care should be taken to remove all particles after installation. Move the panel being cut to a different location to avoid metal shavings or filings getting on other panels.

(Keep Material Dry!)

Wise Line metal Sales panel and trim paint finishes are formulated to withstand severe wet weather and rain conditions. These panels and trims are however not designed to, for a long period of time, be in continuous contact with water. Panels stored outside should be elevated 8" on one end to allow moisture run off. **Panels and trims left in wet storage WILL result in damage.** Be sure to store material that is not going to be installed immediately in a dry location. Wet material should be re-stacked and air-dried if installation is not immediate.

(Eave Flashing)

Eave Flashing gives a finished look along the drip eave of the house, as well as providing protection for the materials they cover. The eave flashing should completely cover the top edge of the fascia. Inside closures, which seal off the open ribs of the panels, are optional, as open ribs allow for better ventilation underneath, which in turn reduces condensation.

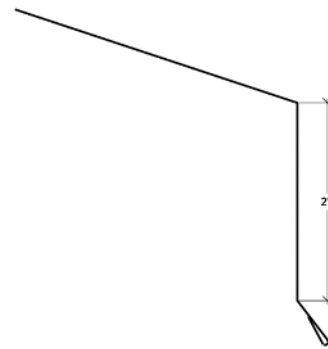
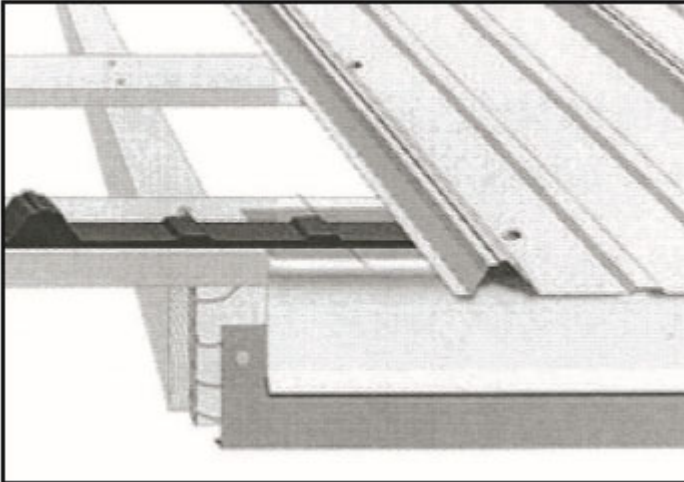

(Pre-Formed Valley)

Pre-formed valleys use a diverter to prevent water from rushing under panels on the opposite side while channeling water off the roof. Expanding foam closures are often used to assure a good seal (Emseal).

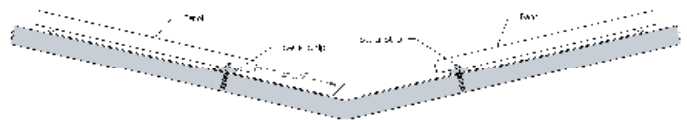
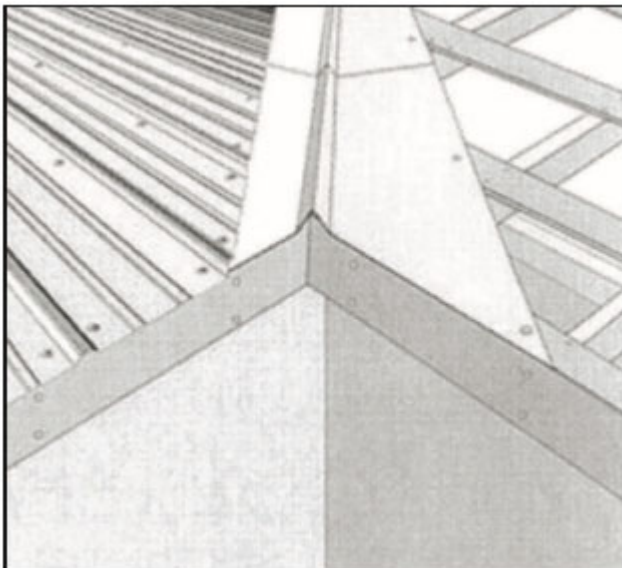

(Gable Flashing)

Gable flashing is used to trim the edge of the roofing panel at the gable end of the roof. It should match the Eave Flashing that extends along the drip edge of the roof. If the panel is allowed to hang over the gable end, Eave Flashing can be used instead. Butyl tape between the trim and panel eliminates leaks.

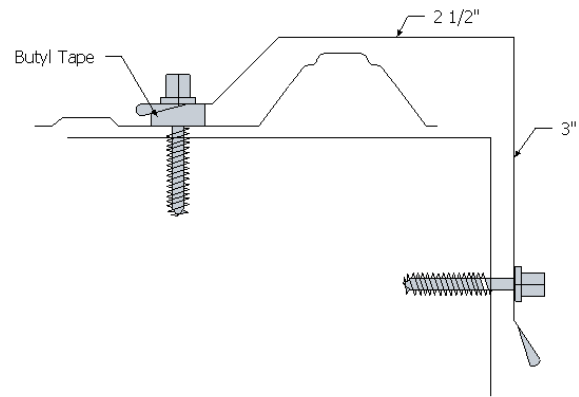
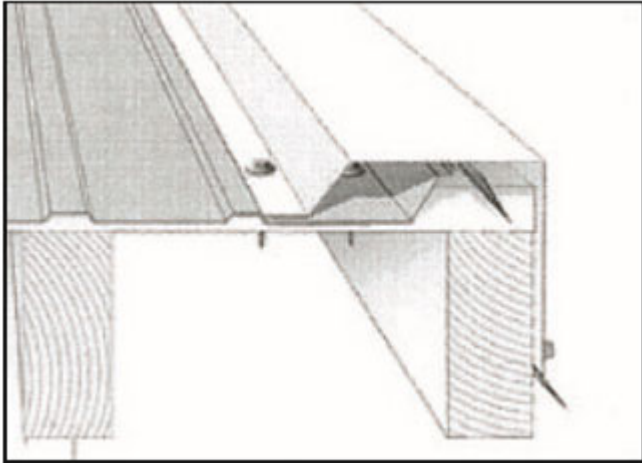

(Side-Wall Flashing)

Side-wall flashing is applied when the side of the roof butts up against an adjacent wall. The wall side of the flashing can either be covered over with siding (Recommended) or sealed with caulk. Butyl tape should be applied where the "foot" of the flashing attaches to the roof.

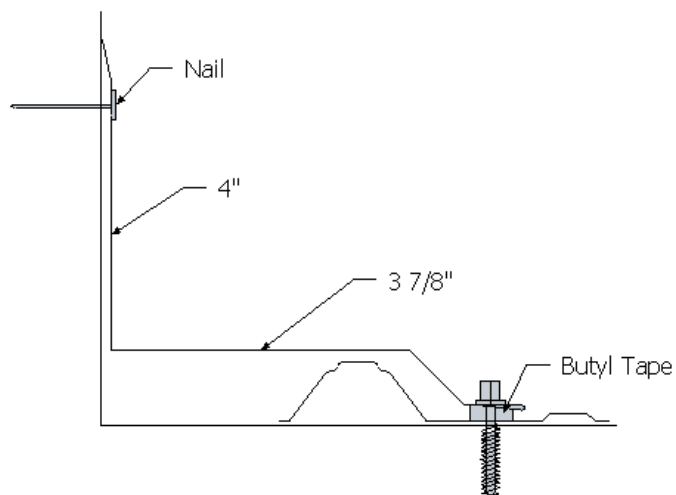
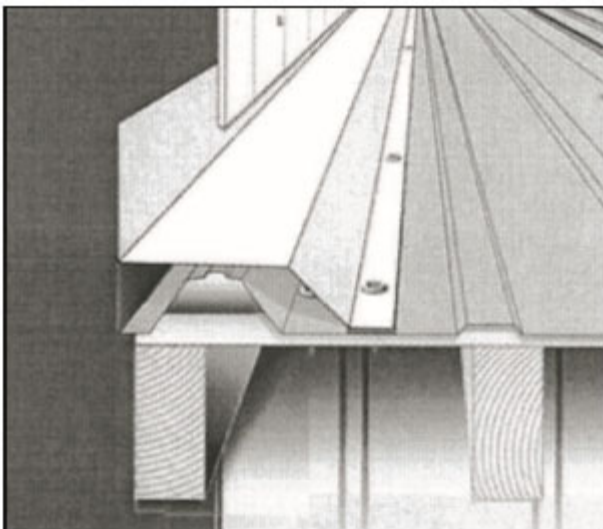

(End-Wall Flashing)

End-wall flashing is applied where the upward slope of a roof meets the wall. The wall side of the flashing can be covered with siding or counter-flashing. Outside closures are necessary to seal between the flashing and the panel. Roof slope should be mentioned and specify which trim piece needed when ordering.

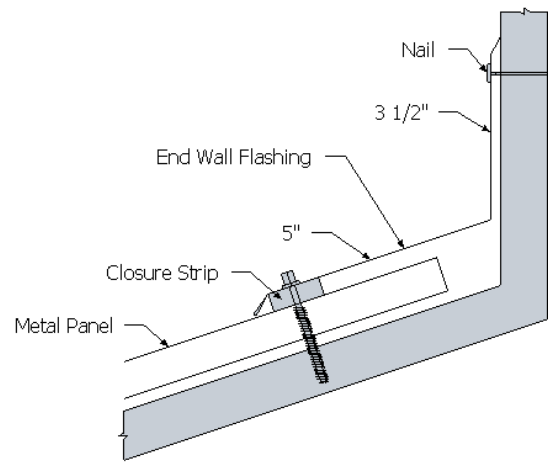
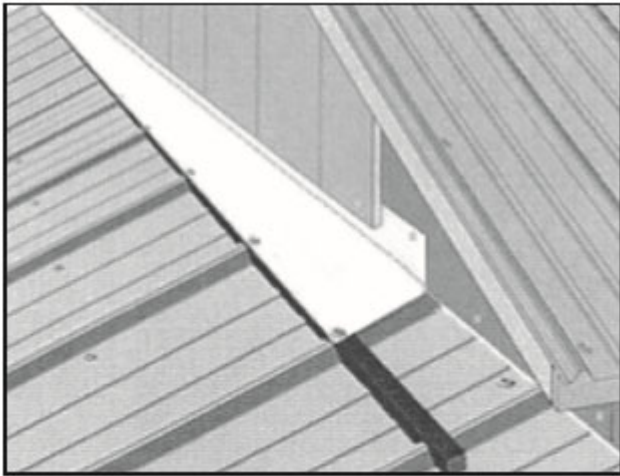

(Pitch Change Flashing)

Transition flashing (Pitch Change) prevents leakage at the point where two different roof pitches meet. It is sealed on the lower side with outside large closures, and can be sealed underneath the upper panels with inside small closures. The transition flashing provides a continuous drainage where two slopes meet.

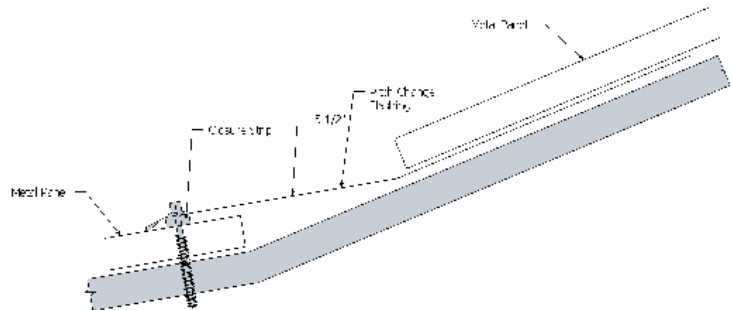
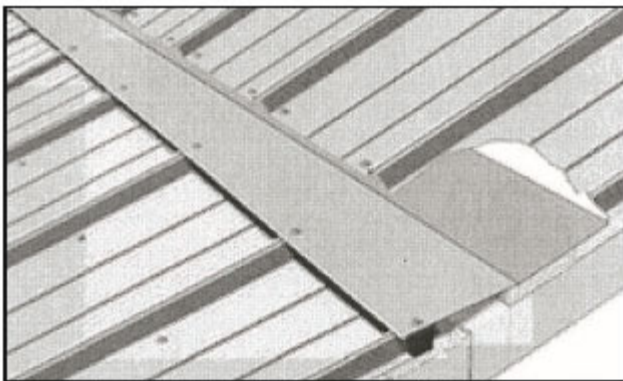

(Ridge Cap)

The Ridge Cap is used to seal the point at which two upward slopes meet. This can be both along the ridge of the roof as well as covering for a hip. Either woodgrip or self-drilling lap TEK screws are applied through the ribs of the metal. Since debris, insects, and blowing rain can find easy access under the ridge cap closures are required to either completely or partially seal the opening. Closures under ridge caps come in two types: solid and vented.

Solid closures (“Outside Closures”) are the same width as the panels. They lock together in a row placed directly under the screws that attach the ridge cap, and form a solid, water-tight, air-tight barrier.

Vented closures are the same lengths as the panels, and form a water-retardant, insect resistant barrier that allows hot air to escape from the attic and is better than many of the other more elaborate and expensive vent systems.

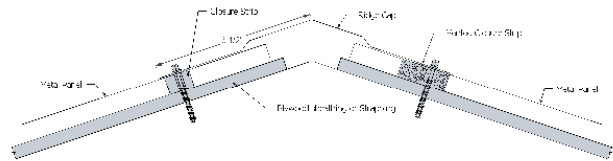

Ridge cap showing outside closure and profile vent.

(Outside Corner)







The outside corner with J is used to make a nice clean finish. It is installed before the wall metal panel. Or corner cap can also be used and customizing corners is often necessary due to their landing on a panel rib (specifying custom dimensions). Be sure to take into account the 3/4" "head space" when figuring custom dimensions.

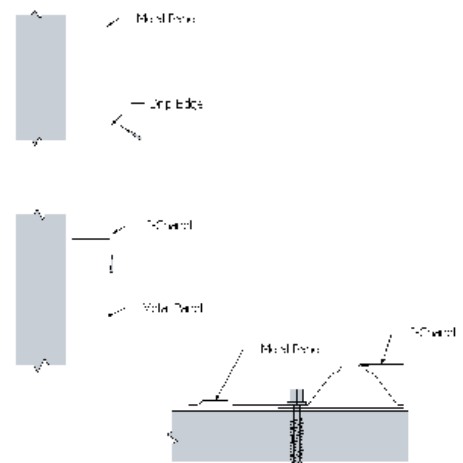
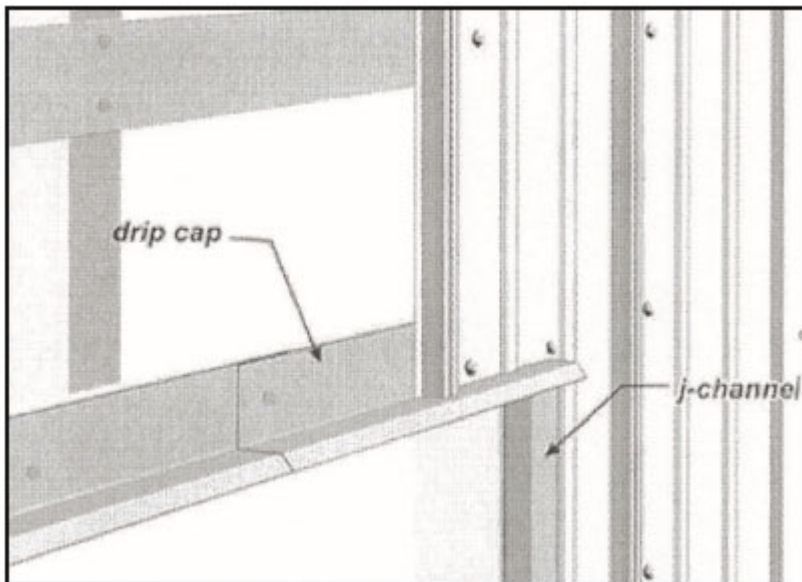

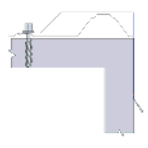
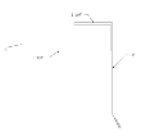
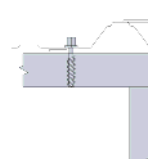

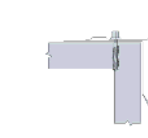

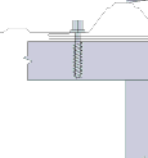
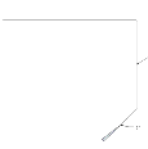
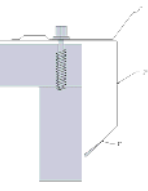
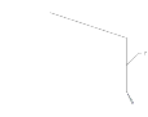
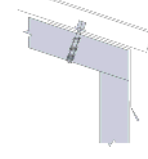

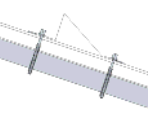

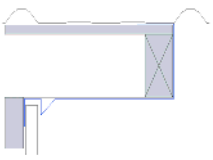
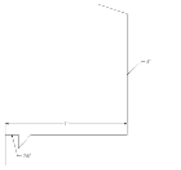



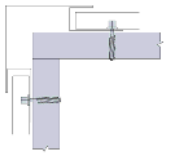
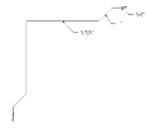
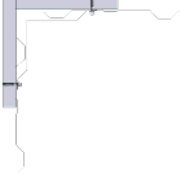

(Drip Cap & J-Trim)

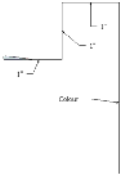
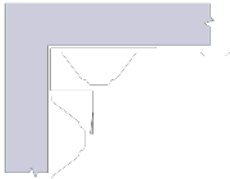
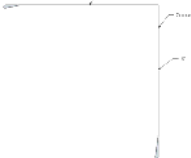
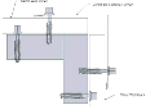
The drip cap is commonly used to trim out the bottom of panels over doorways and windows, and occasionally takes the place of base flashing at the bottom of a wall. J-trim is used to cap raw panel edges where run-off is not a problem and is most commonly used to cap the top sides of skirting, trim around the bottom, sides of windows and doors, and in many cases the top of windows for aesthetics and continuity.

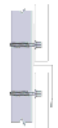

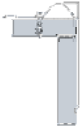
	 <p style="text-align: right;">Diagram 1</p>	<p>Gable Cap – these are placed over the first rib of the metal panel on the start side. Make sure to put seam tape under the Gable Cap to prevent water coming in where the screw penetrates metal panel.</p>
	 <p style="text-align: right;">Diagram 2</p>	<p>Gable Starter – The Gable starter F trim gives the gable a nice finished edge, it hides any cut edges as well. It is installed before the metal roof panels are installed. This trim is for new home installation or where all old roofing is removed.</p>
	 <p style="text-align: right;">Diagram 3</p>	<p>Gable Drip Edge – is installed before the metal roof panels on new roof or where old roofing is removed. Overhang the metal sheet 1" min. to prevent water from getting in.</p>
	 <p style="text-align: right;">Diagram 4</p>	<p>Gable Drip Edge and Gable-J – fasten gable drip edge with roofing nails then fasten gable-J also with roofing nails. (Make sure gable-J is not short of drip edge). Gable-J receives metal roof panel.</p>
	 <p style="text-align: right;">Diagram 5</p>	<p>Reroof Gable – use this trim when installing metal panels over existing old shingles. Fasten reroof gable with roofing nails. Overhang metal sheets min. of 1" each side of roof.</p>
	 <p style="text-align: right;">Diagram 6</p>	<p>Eave Drip – fasten eave drip tight against fascia board or old shingle drip with roofing nails. Overhang metal sheet a min. of 3/4" of the drip edge. (Account for this when measuring for metal sheets).</p>
	 <p style="text-align: right;">Diagram 7</p>	<p>Snow Guard flashing - these are placed horizontally across the ribs of the roof panels to impede or break up the flow of snow off the roof. it is generally placed above entry ways or traffic areas.</p>

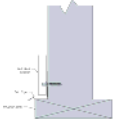
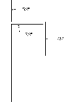
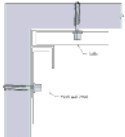
	 <p style="text-align: right;">Diagram 8</p>	<p>Gable Soffit & Fascia <u>w J</u> – Use this when overhang is 8" and wall steel will also be installed. Tack on trim with roofing nails to keep in place. When installing metal sheets be sure first row of screws help fasten trim.</p>
	 <p style="text-align: right;">Diagram 9</p>	<p>Soffit & Fascia <u>w J</u> (Vented or non-vented) – Use this when overhang is 8" and wall steel will also be installed. Tack on trim with roofing nails to keep in place. When installing metal sheets be sure first row of screws help fasten trim.</p>
<p>Wall Channels</p>	<p>Wall Channels Installed</p>	
	 <p style="text-align: right;">Diagram 10</p>	<p>TOC Outside Corner – Install outside wall corner after wall metal is installed. Calculate metal wall sheets so you don't end up with rib directly under screw flange of corner trim.</p>
	 <p style="text-align: right;">Diagram 11</p>	<p>TOCWJ Outside Corner <u>w J</u> – Install outside corner trim before wall metal. Tack corner trim on with roofing nails. When installing wall panels make sure first row of screws goes into flange of corner trim.</p>
	 <p style="text-align: right;">Diagram 12</p>	<p>TIC Inside Corner – Install inside wall corner after wall metal is installed. Calculate metal wall sheets so you don't end up with rib directly under screw flange of corner trim.</p>
	 <p style="text-align: right;">Diagram 13</p>	<p>TICWJ Inside Corner <u>w J</u> – Install inside corner trim before wall metal. Tack corner trim on with roofing nails. When installing wall panels make sure first row of screws goes into flange of corner trim.</p>

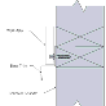
	 <p style="text-align: right;">Diagram 14</p>	<p>TDJ Double-J – Tack on double-J with roofing nails in corner of ceiling and wall to receive wall metal and ceiling metal. Make sure top row of wall screws goes through trim flange.</p>
	 <p style="text-align: right;">Diagram 15</p>	<p>TVOC Versitube Outside Corner – Versitube outside corner installed over the metal wall panels screwed into the rib. Use this corner trim when installing metal wall panel horizontally.</p>
	 <p style="text-align: right;">Diagram 16</p>	<p>TGD Gable Divider – Use this trim to divide the gable metal from the wall metal. Install bottom row of wall metal then tack gable divider overtop to hide ends of metal sheets. Next install gable metal sheets overtop and screw first row into gable divider flange.</p>
	 <p style="text-align: right;">Diagram 17</p>	<p>TJTWJ Jamb Trim w J – Use jamb trim around doors and windows except the top (see next diagram for top jambe trim). Tack on trim with roofing nails then install metal panels. Make sure first row of screws fastens into jamb flange to secure it properly.</p>
	 <p style="text-align: right;">Diagram 18</p>	<p>TJT and TDE Jamb Trim and Drip Edge – Tack on top jamb trim first with roofing nails then tack on drip edge with roofing nails. Install metal panels overtop. Put first row of screws to also go into trim flanges to secure trims.</p>
	 <p style="text-align: right;">Diagram 19</p>	<p>TDJ58 Double-J 5/8" – Use this trim when installing wall metal and soffit. Tack on trim with roofing nails at wall and overhang then install metal wall panels, make sure first row of screws go through the trim flange to secure trim. Screw in soffit with first row going through trim flange.</p>
	 <p style="text-align: right;">Diagram 20</p>	<p>TBT Base Trim – install base trim just above concrete foundation. Tack on with roofing nails to hold in place, then install wall panels and put bottom row of screws low enough to go through trim flange to secure trim.</p>